

BRAKING NEWS

AUTOMECHANIKA AND IAA TRANSPORTATION

Knorr-Bremse TruckServices presents today's and tomorrow's solutions for aftermarket and vehicle manufacturing sector

CUSTOMER FOCUS PAYS OFF

Survey confirms: Knorr-Bremse TruckServices is strong partner for dealerships

EXPERT NETWORK MORE ATTRACTIVE THAN EVER

New services, business models and awards for partner workshops and dealerships

EDITION
65

September 2024 – the Customer Magazine of Knorr-Bremse Systeme für Nutzfahrzeuge GmbH



KNORR-BREMSE

Content

EDITORIAL

- 03** Alexander Wagner, Head of Aftermarket/Truck Services EMEA at Knorr-Bremse Commercial Systems

NEWS

- 04** Highly rated: Survey gives Knorr-Bremse TruckServices top marks for cooperation and expertise.
- 07** Practice beats theory: Train-the-Trainer program becomes Technical Support Forum.
- 10** Potential for serious damage: The risks of counterfeit and gray market products.
- 12** Gripping scenes: Truck racer Jochen Hahn performs brilliantly against tough competition.
- 14** Partnership in action: The Expert Network operated by Knorr-Bremse TruckServices offers dealers and workshops new advantages.

COVER STORY

- 28** Immersive experience: At Automechanika, Knorr-Bremse TruckServices is presenting its ideas for today's and tomorrow's aftermarket.
- 36** Innovative and sustainable: The Knorr-Bremse technologies on offer for automated, connective, zero-emission trucks.

TECHNOLOGY/SERVICE

- 20** Carefully crafted: Highly-automated system for producing air dryer cartridges in Liberec
- 24** Easy to find: Knorr-Bremse TruckServices supplies spare parts for truck braking systems of all brands and types.
- 26** Up2Date

CUSTOMER FEATURE

- 40** Well-regarded brand: A Knorr-Bremse partner since 2015, Martex recently doubled its sales figures.



IMPRINT

PUBLISHED BY

Knorr-Bremse Systeme für Nutzfahrzeuge GmbH, September 2024

Information for Knorr-Bremse customers and partners

DESIGNED AND

PRODUCED BY

ETM corporate publishing und Knorr-Bremse Services GmbH Corporate Marketing

CONTRIBUTORS

TO THIS ISSUE

Simon Basler, Markus Bauer, Sabine Duffner-Beck, Marc Eutin, Thomas Hünseler, Richard Kienberger, Thomas Rosenberger, Georg Weinand, Magdalena Usar

PHOTOS

Knorr-Bremse, MARTEX SP Z.O.O., Richard Kienberger, Zdenek Strupl

GRAPHICS

Knorr-Bremse Services GmbH Corporate Marketing, Anna Lilakewitsch Cathrin Huber

PUBLISHER

EuroTransportMedia Verlags- und Veranstaltungs-GmbH, Geschäftsbereich ETM corporate publishing, Geschäftsführer: Bert Brandenburg und Oliver Trost, Handwerkstraße 15, 70565 Stuttgart © by ETM corporate publishing 2024

CONTACT

bremspunkt@knorr-bremse.com

Dear Reader,

Whether you are a dealer or a workshop, Knorr-Bremse TruckServices firmly believes in maintaining a reliable and profitable partnership with you. Now we are taking our network to a new level that promises even greater advantages - because we believe that you should benefit from your strong commitment to us. In this issue of Braking News you can read about the many advantages offered to your company by our loyalty program.

Our recent survey of Expert Network dealers suggests that Knorr-Bremse TruckServices is on the right track with its strategy. Compared to the previous survey, in which you already rated our cooperation very highly, you have now delivered an even better verdict. We are delighted that you obviously value our partnership, our expertise and the quality of our products so highly. But we are determined to meet even more of your expectations! That is why we will continue to listen carefully to what you have to say, so that we can make further adjustments and achieve an even higher score in two years' time! Please use the next survey to tell us your opinion and give us your suggestions for even further improvement.

In the meantime, this issue of Bremspunkt presents an overview of how Knorr-Bremse TruckServices is shaping today's and tomorrow's aftermarket. Do come and see us at this year's two major trade fair events: Automechanika in Frankfurt and IAA Transportation in Hannover. My team and I will be there to answer your questions and listen to your suggestions. I look forward to meeting you there and inspiring you with our latest concepts and products!

I am sure this trade fair edition of Bremspunkt will once again provide you with plenty of ideas for your day-to-day work. Enjoy the read!

Alexander Wagner



ALEXANDER WAGNER,
Head of Aftermarket/Truck Services EMEA at
Knorr-Bremse Commercial Systems

Customer satisfaction gets even better



WIDESPREAD AGREEMENT: The Knorr-Bremse TruckServices team is perceived as being customer-focused and forward-looking.

Satisfaction ratings among Knorr-Bremse's distributor network are even higher than in the 2021 customer satisfaction survey. The close collaboration with TruckServices, the know-how of the TruckServices experts and the quality of Knorr-Bremse's products all received particularly high ratings.

We're heading in the right direction, with an average of 4.85 out of a possible 6 stars. That translates into an approval rating of over 80 percent. This was the headline finding of the 2023 customer satisfaction survey that Knorr-Bremse TruckServices conducted among its Expert Network sales and distribution partners in the EMEA region. The fact that the overall rating was even higher than in the 2021 survey is a testament to the close relationship between Knorr-Bremse and its partners.

Alexander Wagner, Vice President Aftermarket/TruckServices EMEA at Knorr-Bremse Commercial Vehicle Systems attributes the higher score to the measures that Knorr-Bremse has taken since the last survey. "My thanks to everyone who took part in the survey. We rely on your help to know what matters most to our customers. You help us develop new customer-oriented goals and track our progress in implementing them", says Wagner. He urges all partners to keep participating in future customer satisfaction surveys. "Your answers help us get even better – and ultimately this means you will benefit from optimized products and processes. It's a win-win situation!", declares the Vice President. As Wagner explains, "We've sought to make improvements in several areas since the 2021 survey, and we're delighted that our customers have noticed the difference. Whether it's a stronger focus on customer contact in the shape of more frequent visits, faster response times, the quality of our technical support or warranty periods – we're always ready to listen to what our customers want".

In four of the five categories, the participants in the survey awarded even more stars than in 2021. In the "General" category, collaboration with Knorr-Bremse TruckServices received the highest rating: 91 percent of sales and distribution partners are either satisfied (40 percent) or very satisfied (51 percent). Participants were also asked to choose three qualities that best sum up Knorr-Bremse for them. Almost two thirds described the Company as the market leader and best brand in the braking system segment. "Customer-focused" and "forward-looking" were other popular descriptions. In the "Customer Support" category,



Knorr-Bremse TruckServices improved its rating from 4.84 to 5.04 stars. The technical and sales support hotlines achieved especially high scores of over 90 percent. The highest customer ratings were awarded for Knorr-Bremse experts' know-how and fast response times and for their regular site visits. The rating for the "Product Portfolio" category was 4.8 stars. The range, quality and reliability of Knorr-Bremse's products were all rated very highly by our partners. However, they also identified pricing challenges, especially in price-sensitive regions like Eastern Europe.

The satisfaction scores for the "Logistics" and "Services" categories were more or less the same as in 2021. While the customer rating for delivery performance improved to over four stars, there are clearly still challenges with regard to product

availability and delivery times. Nevertheless, 80 percent of those who took part in the survey said that Knorr-Bremse TruckServices performs well on these counts compared to other similar companies in this market. "We're pleased with the overall results. It's a fantastic achievement by the whole TruckServices team and a testament to the customer focus that is so deeply rooted in our culture. That said, we are ambitious and want to keep building on our strengths." Wagner concludes with a promise: "We also take criticism very seriously because we want to delight all our customers and achieve high scores in every possible area."

Top ratings by category

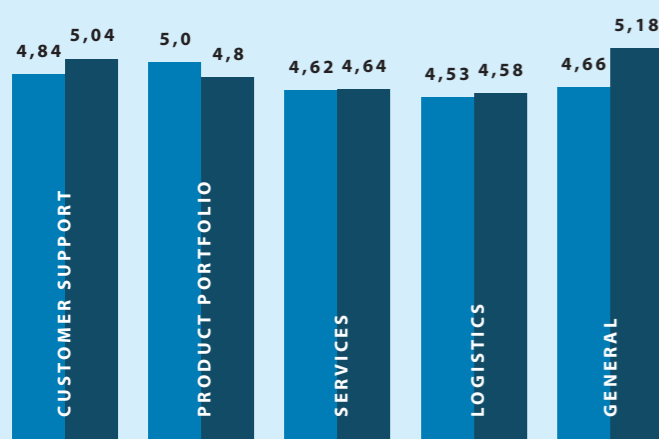

CUSTOMER SATISFACTION SURVEY RESULTS
 ■ 2021 / ■ 2023

IN FOUR OF FIVE CATEGORIES, Knorr-Bremse TruckServices performed better than two years ago. The partners were particularly satisfied with the support provided.

About the 2023 customer satisfaction survey

Knorr-Bremse TruckServices asked almost 700 sales and distribution partners in the EMEA TruckServices network to rate how satisfied they were with its performance in five categories: "Product Portfolio", "Customer Support", "Logistics", "Services" and "General". At the end of each category, participants could answer open-ended questions and give Knorr-Bremse TruckServices a star rating of one to six – the more stars, the better the rating. The overall rating improved from 4.73 stars in 2021 to 4.85 in 2023. Knorr-Bremse plans to use the customer feedback to identify scope for further improvements in specific areas.

Training as a live experience

Knorr-Bremse is developing its "Train-the-Trainer" program into a "Technical Support Forum", with a stronger emphasis on practical training. The current focus is on working with the smart trailer EBS iTEBS® X and the new "Knorr-Bremse Diagnostics" system.



THE TRAINING EXPERTS MET at the start of the Technical Support Forum in Kecskemét, Hungary.

Innovation is an integral part of Knorr-Bremse Commercial Vehicle Systems' DNA. Every time the Company introduces a new product, the Knorr-Bremse TruckServices aftermarket business has to adjust to the new technology - ensuring that the TECH-Support personnel is in a position to support customers with practical tips and technical solutions. This year has therefore seen the TECH-Support experts training all service staff in handling the EBS

iTEBS® X smart trailer and preparing them to switch from the NEO and ECUtalk diagnostic systems to Knorr-Bremse Diagnostics.

In this context an important role is played by the Company's Train-the-Trainer program, which involves TECH-Support truck specialists preparing the trainers of TECH-Support service personnel in working with the new hardware and software solutions. Knorr-Bremse TruckServices has now developed this program into a Technical Support Forum, with

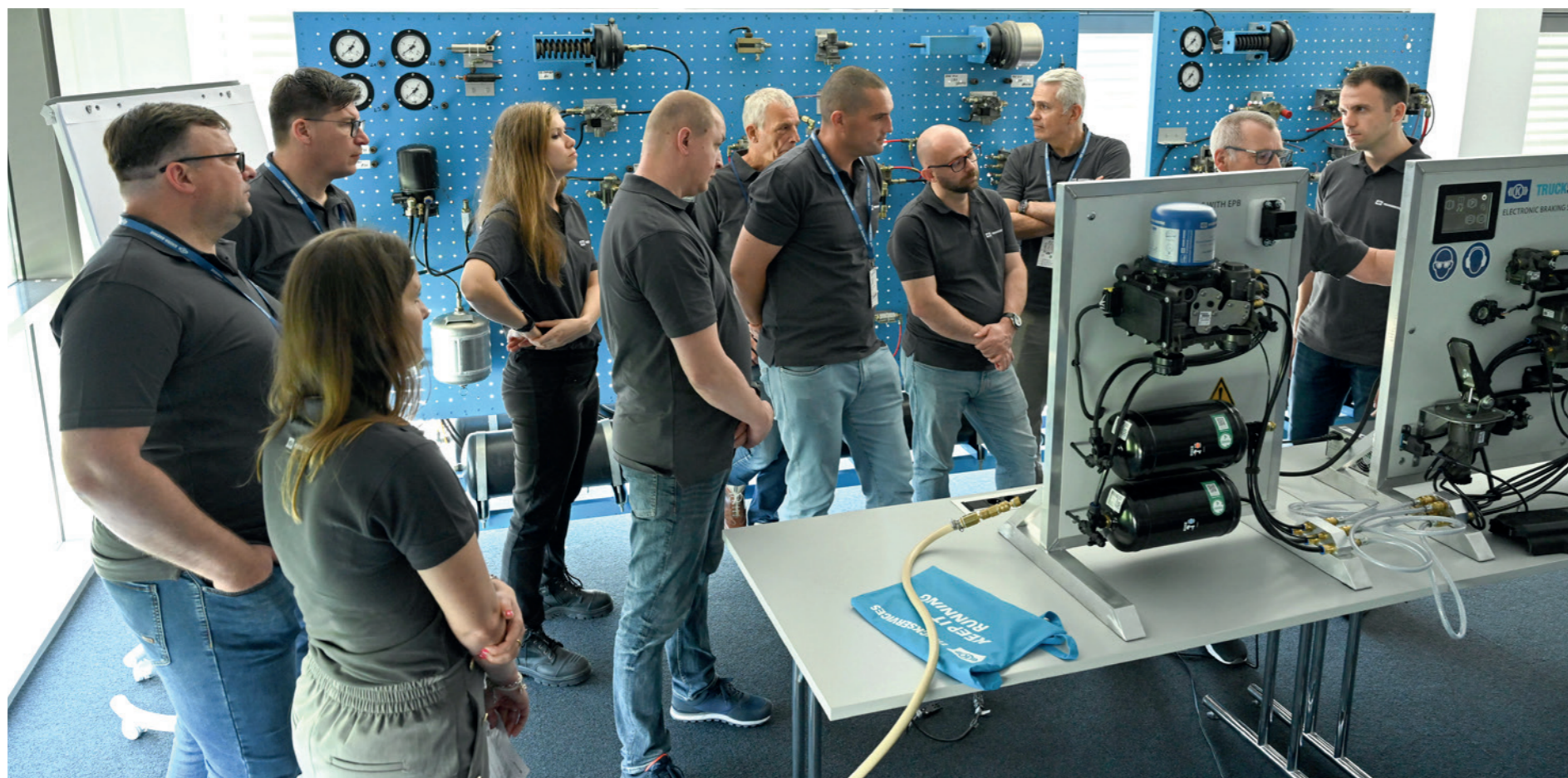

DURING THE TECHNICAL SUPPORT FORUM, TECH-Support staff with special truck expertise prepare the trainers of TECH-Support employees to use new hardware and software solutions.

the aim of further strengthening practical training. "We make the training as practical as possible," says Marc Eutin, Head of TECH Support TruckServices at Knorr-Bremse Commercial Vehicle Systems. "In addition, we only use workshop supervisors who speak to customers on an equal footing - whether they are service experts from workshops, fleets or trade and sales partners - and who know the challenges they face from their own experience." For the introduction of the new generation of Trailer EBS, the Technical Support Forum has two iTEBS® X models available which, unlike a complete trailer, fit into a training room but still offer the full functionality of the Trailer EBS. The system developers provide live demonstrations of the errors that can be simulated on the models and how they can use them to effectively prepare their trainer colleagues. Another focus of training in the Technical Support Forum is the use of Knorr-Bremse Diagnostics – the multi-brand truck and trailer diagnos-

tic system. That is why an expert from Cojali will also be involved in the training provided by the Forum.

"Battling with PowerPoint presentations is now a thing of the past. That's not the way to stimulate interest and encourage participants to engage in discussions," explains Marc Eutin, head of Tech-Support. On the contrary, what is needed are stimulating exciting, practice-oriented demonstrations. As a service expert, Eutin sees personal dialogue as playing a crucial role. "We want to find out where the practical problems lie. That is part of our open error culture." Training is now based on a concept that is standardized across all regions and involves regular reviews of learning objectives, whereas each trainer previously had a great deal of freedom in designing their teaching. "To ensure a consistently high level of training, programs now have a common thread, with didactic support and guidelines on how the training should be carried out. At the same time, trainers have enough freedom to adjust their teaching to local requirements."

Knorr-Bremse TruckServices organizes four Technical Support Forums every year - two at a Knorr-Bremse site and the other two on-line. Thus, for example, the first Forum was launched in the Hungarian city of Kecskemét, where Knorr-Bremse has a facility. "Visiting a plant not only gives participants a break from classroom work – it also enables them to gain a more in-depth knowledge of the Knorr-Bremse products involved," explains Marc Eutin. Representing the hosts, Norbert Sándor, Regional Sales Director for the southern part of Eastern Europe, praised the new approach of the Train-the-Trainer program: "I am grateful for your clear explanations and practical solutions, which are going to help us to face the future with confidence. There has also been a distinct improvement in team spirit."

Knorr-Bremse is upgrading TECH-Support to the status of a service community

Customer training is one of the three pillars of Knorr-Bremse TruckServices TECH-support activities, alongside the telephone hotline and the field service, which provides customers with on-site assistance. In order to provide customers with even better support, Knorr-Bremse has decided - with immediate effect - to no longer exclusively centralize the specification of measures to be taken to help customers in certain cases. The guidelines are now developed through an active interchange within the entire Knorr-Bremse TruckServices community.

"Colleagues are distributed across all regions in which Knorr-Bremse is active, so they are the people who are most familiar with the needs of regional parts dealers, workshops and fleets," explains Marc Eutin, head of TECH-Support. "We are moving away from a silo mentality and using digital communication networks to find rapid, practical solutions. And our customers are already confirming the success of this new approach."

The dangers behind apparent bargains

Counterfeit and gray market products cause billions of euros' worth of damage every year – and also represent a huge safety risk. This is particularly the case when safety-critical components of the braking system are affected by product piracy. Unless you purchase spare parts via official Knorr-Bremse sales channels, you run the risk of their not being original goods – and you can expect serious legal consequences.

Low prices are highly tempting – and this includes the market for spares and wear parts produced by Knorr-Bremse TruckServices. However, in some cases apparent bargains available from online marketplaces, trade fairs or even stores, can turn out to be disappointing or even downright illegal. "This happens, for example, if the manufacturer's trademark rights, patents and intellectual property have been infringed or the customer has been deliberately misled about the product's properties," warns lawyer Dr. Christina Heinzl, Head of Trademarks & IP Legal at Knorr-Bremse. In a worst-case scenario the product is a fake – a replica that looks deceptively like the original and may even be shipped in packaging similar to that used by Knorr-Bremse. However, such fakes are of uncertain origin and functionality. "The customer cannot be certain of the product's quality and performance. For all they know, it may have been refurbished or repaired," says Peter Straub, who works on the enforcement of patents in the Independent Aftermarket division at Knorr-Bremse.

Straub points out that fake products can pose enormous risks, particularly in the case of the kind of safety-critical components manufactured by Knorr-Bremse. If such a

product malfunctions or causes the braking system to fail, the worst-case scenario may be an accident with fatal consequences for those involved. In less serious cases, the service life of the product may be shortened or its functionality may be impaired – resulting at the very least in the supposed bargain costing much more than you had anticipated. That is why, for warranty claims, Knorr-Bremse always starts by clarifying whether the component that caused the functional failure is actually an original KB product – and assumes no liability for counterfeit or incorrectly labelled parts. Even just an attempt to assert a warranty claim for a fake product can backfire: "There can be legal consequences on grounds of attempted fraud," says Peter Straub.

Parts bought on the so-called gray market can also trigger technical and legal problems. They may be originals, but they have been marketed outside the EU and reappeared on the local market via non-official channels, or have been re-imported from another region. Anyone who buys gray market goods runs the risk of becoming an accomplice to a possible trademark infringement. This process is only legal if the importer is in possession of a trademark license from Knorr-Bremse. It entails a high risk for the purchaser of the goods: In many cases, products for the European market have to meet different requirements in terms of safety regulations and type approvals - or they may have different dimensions. Divergent hardware and software versions can also result in incompatibilities. Customers may be in for a nasty surprise: if such a part is used,



FAKE (LEFT) AND ORIGINAL (RIGHT), DIFFICULT TO DISTINGUISH: A price that seems too good to be true may indicate a counterfeit or gray market product.

it can lead to the loss of official approval for the vehicle. If the product turns out to have defects, the buyer must expect to end up paying for the damage or having to accept dealer liability for damage caused to his customer. In extreme cases, this is not just limited to replacing a defective part, but can also extend to consequential damage, for example in the event of a traffic accident resulting in personal injury or death that has been caused by an incompatible part.

Even if fake and gray market products and in particular, originals with counterfeit type plates, are difficult to recognize, there are simple ways for dealers and service companies to avoid falling into the trap. "If an offer seems too good to be true, it probably is," explains Peter Straub. Knorr-Bremse quality is only guaranteed by products that are traded through official Knorr-Bremse sales channels. Anyone who discovers conspicuous or deviating features on the packaging and product, or identifies technical differences, for example, can seek help from the Knorr-Bremse TruckServices experts at any time. In future, the packaging of many Knorr-Bremse products will also be printed using "smart labels". Customers will then be able to easily carry out an originality check using their smartphone camera, or examine the detailed product information. If a check indicates a possible originality problem, the company recommends calling in Knorr-Bremse to investigate the case more closely. "In order to offer all partners, customers and road users maximum protection from the impact of fraud and product piracy and the associ-

Enormous damage caused by product piracy

According to a study entitled "Industrial Security and Product Piracy 2024" published by the German Engineering Federation (VDMA), product piracy is responsible for total financial losses amounting to 4.1 billion euros – the equivalent of 16,000 jobs.

ated legal and economic consequences, Knorr-Bremse consistently pursues all infringements of its intellectual property and contractual delivery regulations by warning letters, injunctions, cease-and-desist declarations, confiscations, scrapping of goods and claims for damages," says Christina Heinzl. "The consequences of such infringements range from recalls and scrapping of fake products and replicas to injunctions and cease-and-desist declarations under the threat of legal proceedings and damages claims," she explains. Anyone buying parts is therefore well advised not to succumb to the temptation of conspicuously low prices, but rather only to use official sales channels.



A contest with nothing in it

The Truck Grand Prix at the Nürburgring is the highlight of the European Truck Racing Championship. Jochen Hahn was keen to impress in front of his home crowd – and he didn't disappoint, consolidating second place in the overall standings.

Twenty-one. It's supposed to take about a second to say it slowly. But in many sports, just a few fractions of a second can be the difference between winning and losing – the time it takes to say "one" rather than "twenty-one". In motorsport too, mere fractions of a second separate the fastest qualifier, who secures the coveted pole position on the grid, from the second and third placed drivers. At 5.922 kilometers, the Slovakia Ring is unusually long – by way of comparison, the trucks cover 3.629 kilometers in one lap of the Nürburgring.

Jochen Hahn finished only 1.65 tenths of a second behind Norbert Kiss in final qualifying on this challenging circuit - a matter of just six meters on the track.

You need to understand this background to properly appreciate Hahn's assessment of his performance: "We carried out a thorough review of the truck and implemented a number of modifications during the break between the last race of 2023 and the start of the 2024 season. We've gained almost a second as a result." In the battle for supremacy in the European Truck Racing Championship, that makes a

PULLING IN THE CROWDS AGAIN: the Knorr-Bremse Go & Stop race on the start and finish straight in front of the main stands. Competitors, including amateur drivers, battle to cross the line first on the 400-meter course without knocking over the posts.

world of difference. And Hahn has indeed managed to significantly close the gap on his rival Norbert Kiss. He feels he has now reached a consistent level. He and his team are planning to make further modifications to the race truck during the summer break together with their partners, among them Knorr-Bremse and Knorr-Bremse TruckServices. "Hopefully that will mean there's nothing between us for the rest of the season and we can take a few checkered flags."

HAHN SHOWED HIS FIGHTING SPIRIT, battling his way up from seventh to second in the second race on Saturday.



Hahn is pleased with how the season has gone so far. The six-time European champion is especially happy with his performance in front of his home fans at the season's premier event, the Truck Grand Prix. "It was a great team effort and I'm very happy with the four second places, although we would obviously have liked to win all four races." The Truck Grand Prix is traditionally the biggest event in the truck racing calendar. So it was fitting that, after a routine first race, the competitors really stepped things up on the Saturday afternoon in championship race number two. A battling performance from Jochen Hahn that saw him fight his way up from seventh on the grid to finish second was instrumental in making this arguably the most exciting race so far this season. With team-mate Steffi Halm crossing the line in first, it was a one-two for "Die Bullen von Iveco" (the Iveco Bulls), the name the pair are competing under in the European team championship. Their spirited performance was greeted with waves of rapturous applause from the thrilled spectators in the stands.

A successful weekend's racing at the Eifel race track allowed Hahn to consolidate second place in the overall standings, a position he has held comfortably since the start of the season, staying well clear of the third-placed driver. Altensteig's famous son had also impressed at the three previous race weekends, underlining his new competitive edge with a victory in the fourth championship race in Zolder. And there was even more delight for Hahn when his son Lukas took second place, making it a one-two for the family firm.

The final three race weekends after the summer break are in Most (Czech Republic), Le Mans (France) and Jarama (Spain).

Goodyear FIA European Truck Racing Championship

Overall standings after race 4 of 7

- 1. Norbert Kiss: 233 Points**
- 2. Jochen Hahn: 178 Points**
- 3. Sascha Lenz: 131 Points**



Knorr-Bremse TruckServices is consolidating its links with its partners. To do so, the Company's aftermarket division is revising the Expert Network and offering partners - be they dealers or service companies - additional benefits, bonuses and services as part of a loyalty program. Measures include new audit processes designed to ensure a standardized level of performance in the EMEA region. Braking News presents the new Expert Network concept for dealers and workshops.

KNORR-BREMSE LISTENS TO ITS PARTNERS and creates audit processes that cater for their needs.

Commitment pays off

Knorr-Bremse TruckServices has completely reshaped its Expert Network partnership for dealers, with a view to establish performance criteria for a sales network in all countries of Europe, the Middle East and Africa and introducing a new, performance-based loyalty program.



"The idea is to reward partners in the Expert Network who are particularly committed to Knorr-Bremse and are prepared to go that extra mile with us," explains Katrin Gienger, Director IAM Sales EMEA at Knorr-Bremse Commercial Vehicle Systems. "A good partnership is all about give and take, and we are keen to continue to grow successfully with our partners together." This applies regardless the size of the company. Against a background of an ever-changing market, Knorr-Bremse TruckServices has also revised its audit process to ensure that it retains the very best partners in its dealer network. Dealers can become part of the Knorr-Bremse TruckServices Expert Network by meeting four mandatory criteria specified in the onboarding audit, but the full audit list actually contains 19 criteria.

If they also meet optional 'expert criteria' during annual audits, partners can collect bonus points under the Expert Network loyalty program and

can then exchange these for various incentives. "The idea is to give something back to our customers that offers real added value," says Korbinian Kutzner, responsible for the new Expert Network dealer concept at Knorr-Bremse Commercial Vehicle Systems.

Parts dealers' feedback about the previous system also played an important role when the audit was being revised. "We specifically drew on their feedback when we were selecting the individual optional and expert criteria. They clearly want a targeted assessment of their work based on meaningful categories that support a successful partnership," he explains. New business areas and products also influenced the process of reshaping the audit specifications. As a result, new audit criteria were

added, and already existing criteria were either adopted in their current form or adapted to changed circumstances. Audit criteria that were no longer relevant were dropped.

For example, partners can now collect points with marketing campaigns for Knorr-Bremse, by undergoing training with Knorr-Bremse TruckServices or for providing information on regional market conditions. A bonus is also awarded to companies that have a good track record of returning old parts for remanufacturing and that support the Knorr-Bremse voucher system, which offers non Knorr-Bremse

DEALERS CAN BECOME PART of the Knorr-Bremse TruckServices Expert Network if they meet the four mandatory criteria of the onboarding audit. Together with its partners, Knorr-Bremse TruckServices aims to increase sales of parts.

COMPANIES WITH A GOOD RECORD of returning old parts for remanufacturing earn bonus points that can be used to buy rewards.

The new audit system contains

- 4 Mandatory criteria
- 7 Optional criteria
- 8 Expert criteria

workshops and fleets discounts on Knorr-Bremse products and encourages them to explore the Knorr-Bremse portfolio.

Knorr-Bremse TruckServices will be announcing all the details of the new Expert Network for dealers during the Automechanika trade fair in Frankfurt. The first audits under the new system will begin at the end of this year. All partners and those who want to become partners will then be able to experience for themselves the kind of partnership in action at Knorr-Bremse TruckServices.





Expanding partnership with workshops

THE NEW EXPERT NETWORK is aimed at independent and brand-affiliated workshops as well as fleet management companies.

Knorr-Bremse TruckServices is boosting the attractiveness of its "Expert Network" workshop concept by offering all partners - whether independent, brand-affiliated or fleet workshops - extended support, new business models and a performance-based loyalty program.

Knorr-Bremse TruckServices is moving to the next level by significantly expanding its own "Expert Network" workshop concept, focusing on Knorr-Bremse products and services. "We want to take collaboration with our partners to the next level by offering them across-the-board technical support, more efficient business processes and new sources of customers," says Stefan Schmiedt, Director Knorr-Bremse TruckServices Technical Solutions EMEA. The offer applies irrespective of the type of workshop involved. "Any company that wants to optimize and expand



INSTEAD OF THE PREVIOUS TWELVE MONTHS, Expert Network Partners now receive a 24-month warranty on all Knorr-Bremse products.

its range of services is welcome to contact us - whether it is an independent, brand-affiliated or fleet workshop" he explains.

Knorr-Bremse partners will benefit from further business opportunities and optimized services in addition to the Expert Network's tried-and-tested operations. For example, they will enjoy extra-efficient warranty processing,



ONE BENEFIT FOR SERVICE companies is extra-efficient warranty processing.

with response times tailored to their requirements. Furthermore, Expert Network partners will receive a 24-month warranty on all Knorr-Bremse products instead of the current twelve months. The new digital solutions offered by Knorr-Bremse TruckServices in the field of repair and maintenance management as well as the analysis and possible optimization of internal processes, will generate additional business and increase workshop efficiency. Furthermore, workshops will have the option of tapping into an additional source of business as installation partners for the retrofit portfolio.

Knorr-Bremse TruckServices conducts regular audits for any companies wishing to become service partners, giving them an opportunity to demonstrate their expertise, the quality of their work and their active collaboration with Knorr-Bremse. Knorr-Bremse TruckServices has also reviewed this procedure and developed a system of incentives involving both mandatory and optional assessment criteria. According to Stefan Schmiedt, above-average performance during the partnership evaluation makes it possible to collect additional expert points and thus receive attractive bonuses. "The idea behind the incentive program is to motivate workshops to expand their knowledge of new Knorr-Bremse products and their use of Knorr-Bremse services," explains Schmiedt. "We support

them regardless of the commercial vehicle segments in which the workshop is operating." An integral part of the workshop concept is Knorr-Bremse Diagnostics, which has recently been integrated into the Jaltest diagnostic hardware. This offers workshop partners the option of easily upgrading the diagnostic software to a multi-brand version. By combining Jaltest and Knorr-Bremse diagnostics on one device, customers' acquisition costs are reduced. They also have the option of booking additional technical support for commercial vehicle multi-brand diagnostics/repair with Knorr-Bremse TruckServices.

The Automechanika trade fair in Frankfurt (see p. 28) or the IAA Transportation in Hanover (see p. 36) will offer a perfect opportunity to find out more about the benefits of the newly-established Expert Network for workshops prior to its market launch at the start of 2025.

Workshops interested in the Alltrucks full-service workshop concept with multi-brand expertise in diagnostics, service, maintenance and repair are also cordially invited to visit us at the trade fairs Automechanika and IAA Transportation.

1,400 meter marathon for air dryer cartridges



Moisture has no place in a commercial vehicle compressed air system, as condensation from the air endangers valves, air reservoirs and cylinders and can impair braking performance. Air dryers protect the compressed air system and ensure the vehicle's safety. For more than 25 years, Knorr-Bremse has been manufacturing conventional desiccant cartridges for vehicles with low air consumption and OCS desiccant cartridges oil separators for all other applications, at its plant in Liberec, Czech Republic. The production line is highly automated and combines the cleaning, painting and printing process of the blank housings as well as actual cartridge production and assembly. During the process, each cartridge covers a distance of 1,400 meters via countless twists and turns, lifting and rotating devices, before it ends up being packaged and dispatched.

KNORR-BREMSE PLANT IN LIBEREC
(CZECH REPUBLIC)

Step 1

Washing the housings

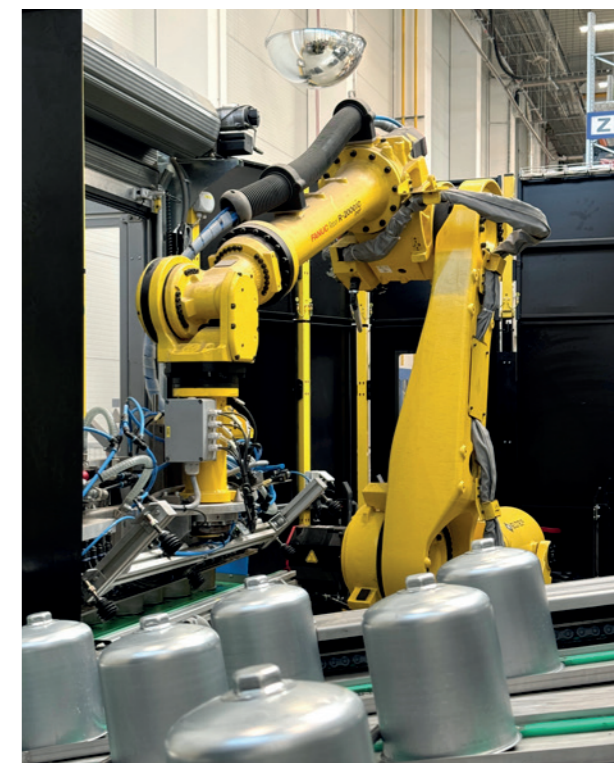

A robot removes the raw cartridge housings from a pallet and feeds them into the washing system batch by batch. They then pass through the so-called 'tunnel', where they are cleaned and dried. Once they are sparkling clean, they are ready for painting.

Step 2
Painting and drying



In addition to cartridges for its own aftermarket requirements in the typical shade of blue, Knorr-Bremse also produces cartridges for customers in a variety of different brand colors. This task is also highly automated and carried out by robots. Their high precision in applying the paint enables them to meet customers' demanding quality requirements.

Step 3
Printing and branding



Another machine customizes the painted cartridges according to the customer specifications, printing the respective logo and other information about the cartridge replacement on it. Knorr-Bremse monitors each individual housing by camera and compares it with the technical specifications to ensure high production quality.

Step 4
Container assembly

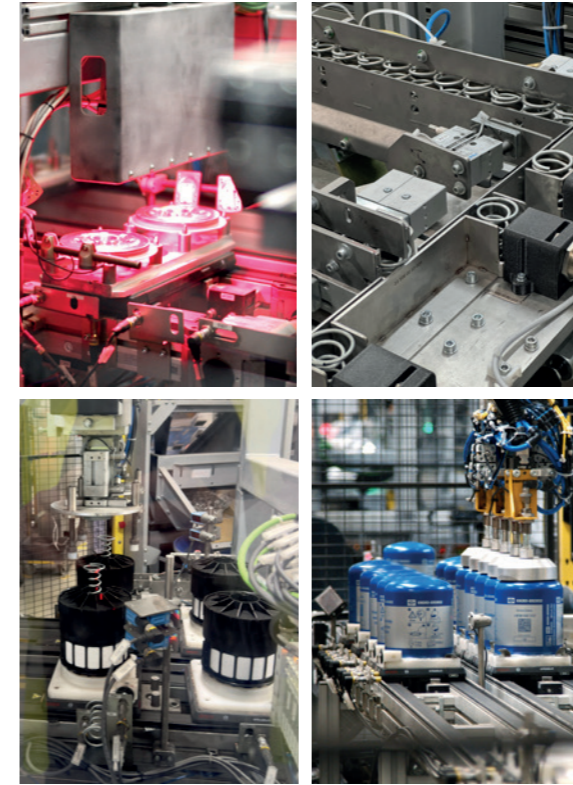

Once the housings are resplendent in the chosen colors and all the necessary information on how to replace the cartridge has been printed on it, the next stage is final assembly. Machines combine the product-specific components of the air dryer cartridge, such as springs, filter insert, oil filter, desiccant, seals and brackets. The individual elements are then automatically taken from various containers, fed to the conveyor belt and installed.

Step 5
Seaming



This is the final step. The filter cartridge is now completely sealed and can effectively protect the vehicle's braking system. From the last transfer station, the finished product is sent for ID printing and finally to the automatic packaging system.

Knorr-Bremse sticker cartridges

Knorr-Bremse TruckServices offers the ideal cartridge for every commercial vehicle, regardless of brand, type and age. There is a choice of both brand-new and industrially reconditioned parts in various versions, for example with oil separator function or in a high-pressure version. Aftermarket customers of Knorr-Bremse can customize a 360-degree label for their cartridge - similar to the versions for original equipment customers. This is produced on the OE line, with corresponding production slots still available to be booked for the coming year 2025.



KNORR-BREMSE TRUCKSERVICES 360-degree sticker cartridges from the "Thank you" campaign.

Figures, data, facts

Knorr-Bremse has more than **25 years'** experience in air drying and oil filtration. Over the past twelve years, the company has sold more than **30 million*** OE-quality air dryer cartridges. The filter cartridge production covers an area of **1,300 square meters**. During the production process the cartridges travel a distance of **1,400 meters**. Knorr-Bremse offers a **wide range of color options**, the most common being white, blue, green, black, silver, and gray.

* Based on global market share in air treatment products for commercial vehicles.

Premium-quality brake pads and discs



SINGLE SOURCE:
High-quality spare parts for the entire braking system and for every age of vehicle.

Whatever type of top-quality spare or wear part (including appropriate tool) you need for your commercial vehicle's braking system, Knorr-Bremse is the company to turn to. More than 50 million disc brakes produced for pneumatic braking systems* bear testimony to customers' confidence in Knorr-Bremse's OE quality.

Knorr-Bremse TruckServices' mission is to supply all customers with the most comprehensive range of spare & wear parts from a single source – high-quality, economical solutions for vehicles of every type, age and braking system. The portfolio includes brake discs and brake pads, as well as discs for hydraulic braking systems and drum brake pads. Drawing on over 40 years' experience of developing pneumatic disc brakes, its consistent focus is on safety, reliability and low life-cycle costs, as well as sustainability.

The brake pads in Knorr-Bremse's wear parts portfolio also meet the Company's same high quality standards and come from a proven OE supplier with a reputation for high manufacturing standards, careful selection of raw materials and precise workmanship. Top quality is ensured by testing that goes beyond the requirements of the ECE R90 directive. The Knorr-Bremse brake pad material quality designation means customers can rest assured that aftermarket brake pad kits are suitable for the specified application and will benefit from the latest product innovations and upgrades. This includes the use of particularly sustainable and environmentally friendly materials such as copper-free brake pads, which generate significantly fewer particulate emissions during use. In combination with Knorr-Bremse brake discs, the pads guarantee ideal friction pairing - combining

*based on the global market share of disc brakes for commercial vehicles with pneumatic braking systems

top braking performance with long service intervals and short vehicle downtimes. In addition, brake pad kits designed for combination with ACR (Active Caliper Release) or APR (Active Pad Release) help to reduce fuel costs and optimize brake pad wear.

In the case of brake discs for the Aftermarket, Knorr-Bremse Truck-Services also focuses on the use of high-quality materials that comply with OE specifications and significantly increase the service life of the brake discs compared to third-party products. Cooling time is also reduced thanks to the special design of the cooling channels and the use of material that has been optimized for commercial vehicles. Improved heat conduction and lower operating temperatures also offer improved resistance to thermal cracking. Here too, comprehensive quality controls ensure that the product meets all the requirements of ECE R90.

NO COMPROMISES IN TERMS OF SAFETY AND EFFICIENCY:
The new Knorr-Bremse brake pads for SyT7 (NexTT®) brakes.



Up2Date

■ Pneumatic Disc Brakes Type SyT7 (NexTT®) (Y514892)



■ Launch of Knorr-Bremse Diagnostics (Y548401)



■ Special Tools and Auxiliary Tools: Comprehensive Solutions from Knorr-Bremse (Y322340)



■ New: Digital Service Manual (eService Manual) (Y477671)



■ Knorr-Bremse NG4 EVO PRO Spring Brake Actuators for pneumatic disc brakes for trailer applications (e.g., Schmitz-Cargobull) (Y502115)



■ Knorr-Bremse TruckServices Brake Discs extension (Y541027)



The documents can be downloaded at

<https://mytruckservices.knorr-bremse.com>

Simple search



With the online Brake Parts Finder from Knorr-Bremse TruckServices, searching for spare parts for brakes is child's play.

The digital Brake Parts Finder from Knorr-Bremse TruckServices offers extreme user-friendliness, regardless of the end device concerned. The online search system is optimized for use with a laptop, tablet or smartphone, and the intuitive icons and clear structure mean that navigation is child's play. Users do not have to waste time searching for drum brake linings and disc brake pads and discs. Simply by clicking on the relevant part number, they are immediately transferred to the details page in the Knorr-Bremse TruckServices online customer portal and can place their order straight away.



<https://truckservices.knorr-bremse.com/wheelend-parts-finder>

WHETHER WITH A SMARTPHONE or another end device: the online search function is convenient.

automechanika
FRANKFURT



Tomorrow's aftermarket solutions – experienced digitally

Knorr-Bremse TruckServices, the commercial vehicle aftermarket division of Knorr-Bremse, is inviting visitors to a "Digital Experience" of its new brand identity at the Automechanika 2024 trade fair in Frankfurt am Main (September 10-14, 2024). In Hall 3.0, the company will be showing visitors a wide range of solutions for the future ecosystem in a digitalized aftermarket. Other topics will include revised partnership concepts for dealers and workshops, an optimized diagnostics solution, and a control unit repair strategy - as well as numerous new products, retrofit solutions and services.



A SUCCESSFUL CONCEPT: Back in 2022, Knorr-Bremse presented its solutions at Automechanika mainly in digital form - a move that was very well received by customers.

"TruckServices Future-ready Aftermarket. Products & Services for Today. Solutions for Tomorrow" – this is the new motto under which Knorr-Bremse TruckServices will be appearing at the Automechanika trade fair in Frankfurt. "The current transformation of the commercial vehicle industry offers fleet operators numerous opportunities to boost their efficiency and sustainability. Our TruckServices portfolio offers the right

solutions across the entire value chain and vehicle life-cycle," explains Bernd Spies, Member of the Executive Board of Knorr-Bremse AG responsible for the Commercial Vehicle Systems division. Spies is looking forward to meeting customers to discuss, among other things, new partnership concepts for dealers and workshops, as well as

the benefits of Knorr-Bremse's partnership with Cojali - the experts in the field of multi-brand diagnostics for trucks and trailers. "The new Knorr-Bremse TruckServices slogan combines the power and customer benefits of our current rapid support services with a range of innovative, future-oriented solutions," adds Alexander Wagner, Head of Aftermarket/TruckServices EMEA at Knorr-Bremse Commercial Vehicle Systems. Knorr-Bremse's aftermarket division helps dealers, workshops and fleet operators develop new business models that further boost their efficiency. "I am very much looking forward to introducing all our customers to the scope for adding further value," he explains.

In addition to an exchange of expertise, the focus will be on a "Digital Experience": Knorr-Bremse TruckServices, the commercial vehicle aftermarket division of Knorr-Bremse, will take visitors on a voyage through a new ecosystem – the digitalized aftermarket. The exhibition booth, which covers more than 300 square meters and boasts five app-controlled monitors and two LED screens, will invite visitors to immerse themselves in the aftermarket ecosystem of the future as they take an interactive journey through the range of services offered by Knorr-Bremse's aftermarket division. In the role of virtual fleet or workshop manager, they will experience some of the planned - and unplanned - servicing requirements that can occur during fleet operations, and learn about the solutions provided by Knorr-Bremse TruckServices across the entire value chain. One example is the new workshop booking system PleaseFix, which assists customers in planning, booking and tracking repairs and maintenance. This not only enables workshops to further improve processes and maximize capacity utilization but also offers them scope to expand their customer base by gaining

access to new fleets. On the other hand, Knorr-Bremse TruckServices is also presenting a workshop benchmarking system in cooperation with Dutch company WESP, which enables commercial vehicle service companies to identify potential for increasing sales and process efficiency.

At Automechanika Knorr-Bremse will also be presenting its revised Expert Network concepts for dealers and workshops - with a focus on closer cooperation and an extended range of support and services. This edition of Bremspunkt presents all the details from page 14 onwards.

Knorr-Bremse and Cojali also offer a Europe-wide repair service for more than 2,500 types of electronic control units in trucks, buses, off-road and agricultural vehicles. By opting for repair, customers are choosing an environmentally friendly and economical solution that saves around 20 percent of

KNORR-BREMSE'S MODERN BOOTH CONCEPT with central discussion islands invites visitors to engage in technical discussions.

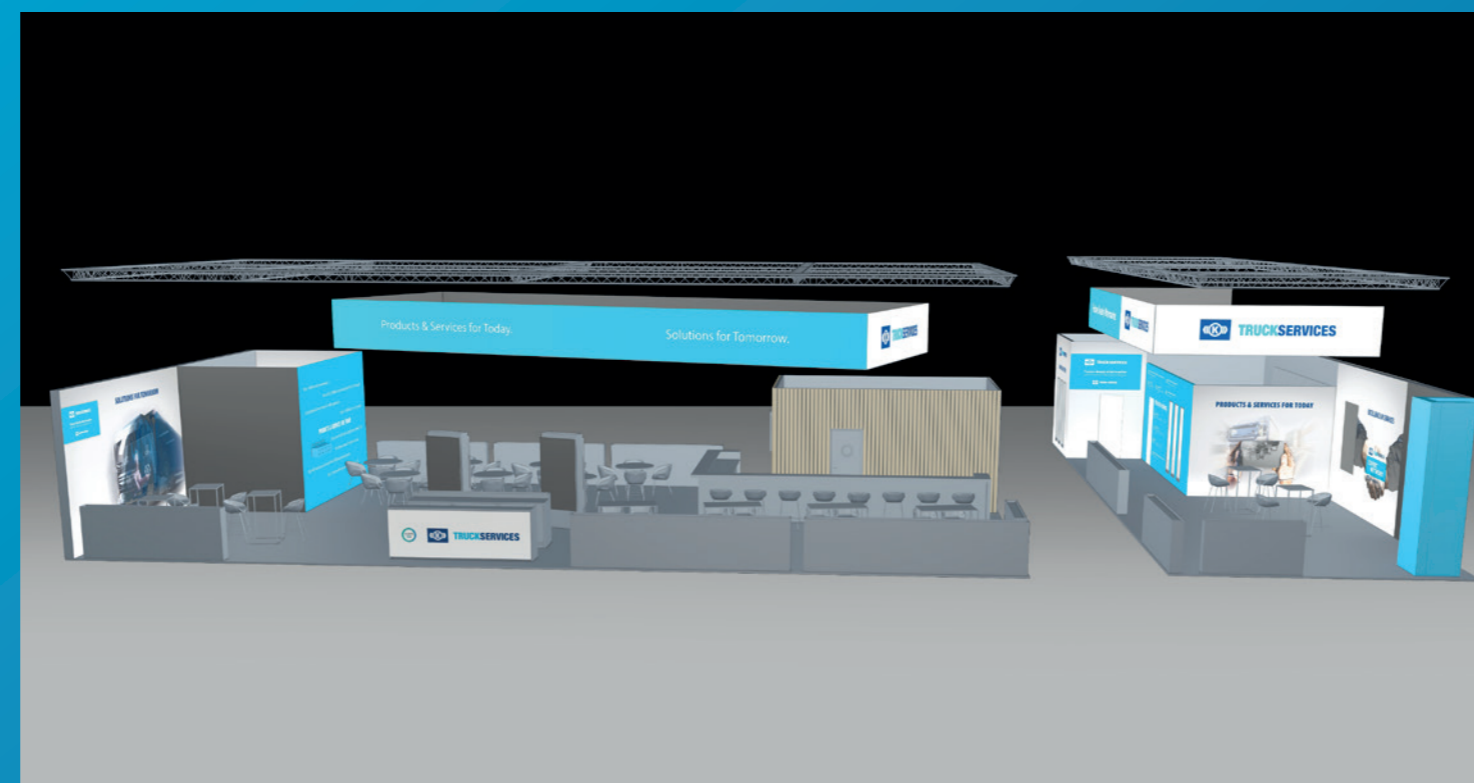

the costs and significantly reduces electronic waste compared to buying a new product.

Diagnostics play a key role in ensuring efficient workflows in a modern commercial vehicle workshop. Knorr-Bremse Diagnostics, a multi-brand system developed in collaboration with Cojali, is a pioneering system based on Jaltest Diagnostics- the user interface of Cojali's cross-brand commercial vehicle diagnostics software. Running on Cojali's



GLOBAL SCALABLE AIR TREATMENT (GSAT)



ROTARY VANE COMPRESSOR



NEXTT° SYT7



NG4 EVP PRO BRAKE CYLINDER

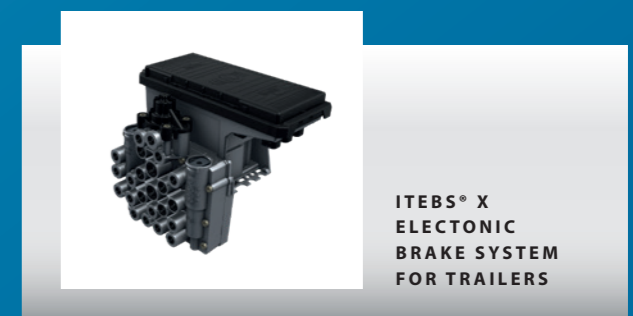

ITEBS X ELECTRONIC BRAKE SYSTEM FOR TRAILERS

Jaltest link hardware, this new software combines the diagnostics of Knorr-Bremse truck and trailer systems, following on from the NEO software packages for truck systems and ECUTalk® for trailer systems. Knorr-Bremse Diagnostics is based on a subscription model and can be acquired as a stand-alone solution for Knorr-Bremse systems. It is also possible to obtain the Knorr-Bremse add-on together with the Jaltest Diagnostics multi-brand diagnostic system, which also effectively covers multi-system fault scenarios. Workshop customers benefit from a unique degree of diagnostic depth during the repair process, for Knorr-Bremse, as an original OE supplier, can contribute its know-how in specific diagnostic functions and provide guided repair instructions. In addition, Knorr-Bremse Diagnostics includes as standard the diagnostic solution for iTEBS® X, the latest intelligent trailer EBS generation from Knorr-Bremse, which is in series production. To provide an optimal link between iTEBS X and the digital world, Knorr-Bremse and Cojali have designed and



IN ADDITION TO FIVE MONITORS, two large LED walls are also available for exploring Knorr-Bremse's solutions.

Expert Network

Knorr-Bremse TruckServices will be presenting revised Expert Network concepts for dealers and workshops and the associated added value for its partners. Read more on page 14.

brought into series production a cloud-based configuration platform OCT (Online Configuration Tool). Together with the smart service concept, OCT enables future-proof diagnostics in compliance with new regulatory requirements, for example for software update management in accordance with UN ECE R156 and cybersecurity in accordance with UN ECE R 155.

Innovative original components from Knorr-Bremse also help reduce the life-cycle costs of commercial vehicles. One new addition to the Knorr-Bremse

TruckServices portfolio is the NG4 EVO PRO combination cylinder for pneumatic disc brakes in trailers. A combination of the NexTT® SyT7 brake and the NG4 EVO PRO brake cylinders with increased parking brake force enables optimum braking and increases vehicle safety. The wheel-end for demanding applications is already being used successfully in a fleet trailer customer's nine-ton trailer application. The innovative design of the brake cylinder includes full crimping (service and emergency brake element) and a completely sealed parking brake element, which effectively protects the



internal components from contaminants such as dust, dirt and moisture, thereby increasing the product's reliability and durability.

The well-established Active Caliper Release (ACR) system has now been followed by Active Pad Release (APR). Similar to ACR but designed for the new SYNACT® brake generation, the APR retrofit solution reduces residual brake torque by actively releasing the pads from the disc with the aid of a spring system. This reduces wear, brake pad particulate emissions, fuel consumption and, ultimately, the



THE BOOTH WILL ALSO FOCUS ON aftermarket products for e-mobility and for improving the energy efficiency of vehicles.

vehicle's CO2 footprint. Knorr-Bremse is initially supplying the retrofit solution for SN7 and ST7 brakes, but will gradually expand the number of applications in the future. APR is designed in such a way that retrofitting can be carried out quickly and cost-effectively. In conjunction with the APR system, Knorr-Bremse uses the high-quality environmentally-friendly, copper-free linings that have already been introduced in the European aftermarket.

The Global Scalable Air Treatment (GSAT) technology platform follows on from previous

generations of electronic air treatment (EAC) and is expected to be available as an aftermarket service solution by the end of the year. GSAT implements all functions and meets all legal requirements in a scalable and consistent manner for all vehicle types world-wide. The system can be monitored using Knorr-Bremse Diagnostics, and its modular design allows for cost-efficient replacement of individual components. Knorr-Bremse offers the repair kits, cartridges, air dryer module and multi-circuit protection valve for this purpose. GSAT also enables control of

electric compressors such as the Rotary Vane Compressor, which is available for the aftermarket and is designed for electric commercial vehicles with low to medium air requirements. Available in three variants, it forms the Electric Vane Module (EVM) together with a compact electric motor. Knorr-Bremse TruckServices offers numerous user-friendly service kits for the Rotary Vane Compressor, tailored to components such as the air filter or electric motor.

Even the special and auxiliary tools available from Knorr-Bremse TruckServices prove to be effective in enabling workshops to save time and money. The latest addition to this range is the PipeMarker, which makes it easy to mark the electronic air treatment system piping, enabling components to be quickly and safely serviced or repaired. Visitors to the trade fair can try this out for themselves - they can receive this clever little helper as a gift!





THE BOOTH IS MADE UP OF INDIVIDUAL CONTAINERS. Visitors will find information on the various areas of innovation such as zero emissions, automated driving and driver assistance systems

With an eye to the truck of the future

Commercial fleet vehicles must be economical, safe and sustainable. Working in close partnership with vehicle manufacturers, Knorr-Bremse is rapidly developing the technologies required for the necessary electrified, autonomous and digital solutions. The company aims to introduce its innovative solutions for transforming road transportation to trade visitors at IAA Transportation 2024 in Hannover (September 17-22, 2024). Knorr-Bremse invites industry guests interested in talking technology to visit Booth C21 in Hall 12.

Bernd Spies, Member of the Executive Board of Knorr-Bremse AG with global responsibility for the Commercial Vehicle Systems division, emphasizes that: "As a leading manufacturer of safety-critical systems for trucks, trailers and buses, our core values of safety and innovation are priceless attributes in a marketplace that's rapidly changing, and in a society where attitudes are becoming increasingly sustainable. By listening very carefully to our customers and industry operators, we analyze market trends at an early stage. Our findings and insights help to shape our innovative, safety-critical systems – with them, we support our customers as development partner, problem solver, and very often as pacesetter. Which is why I'm so much looking forward to sharing ideas with like-minded industry professionals at IAA Transportation."

At IAA Transportation 2024, Knorr-Bremse's presence will take the form of a sustainable booth concept based on robust, high-quality containers intended for repeated use and reuse at future exhibitions. In fact, Knorr-Bremse is planning to use the trade-fair exhibits and their digital contents as part of a follow-on truck roadshow featuring on-site presentations to selected customers. The hub of the booth is a central display that will use exhibits and multimedia product tours to immerse visitors in the world of Knorr-Bremse solutions. Customers will find out how Knorr-Bremse's understanding of systems and the resulting technological innovations are making a major contribution to the truck of the future – because Knorr-Bremse has developed a broad range of safety-critical solutions in response to transformative industry trends. These include ZERO-emission solutions in support of e-mobility, redundancy concepts for automated driving, and new

IAA TRANSPORTATION

products and business models based on digitalization. In all cases, the common factor is road safety, deeply embedded in Knorr-Bremse's DNA and the guiding principle behind the company's development of new products and product upgrades. Similarly, Knorr-Bremse's vision of sustainability is directly reflected in the company's business processes and products. For manufacturers and operators, sustainability is all about support for a circular economy, reduced emissions and lower energy consumption. Knorr-Bremse pursues these sustainable objectives by embedding EcoDesign – the eco-friendly approach to product design – in the heart of the company's development efforts and trade-fair presence.

System solutions for enhancing road safety are among Knorr-Bremse's core competencies. The results of this expertise may be found in the company's latest developments for braking systems, driver assistance systems, steering, air supply and air treatment systems, as well as its innovative solutions for trailers. For example, in the field of braking technology the modular SYNACT® disc brake family includes axial and radial brakes. SYNACT® saves as much as 48 kilograms of weight per vehicle, and uses Active Caliper Release (ACR) to cut fuel consumption. The latest, state-of-the-art generation of the Global Scalable Brake Control (GSBC) system – representing a global, modular approach to system design – has just enjoyed a successful market launch. This year, Knorr-Bremse will become the first manufacturer to put an EBS system into mass production in the



IAA » TRANSPORTATION

USA. And on the innovations side, the company will introduce its new Electromechanical Braking System (EMBS), boasting multiple advantages in terms of installation space, noise emissions and precise control.

With its Advanced Driver Assistance Systems (ADAS), Knorr-Bremse have made the company a partner of choice for companies implementing EU General Safety Regulation II (GSR II), which came into force for first vehicle registrations on July 7, 2024. Among other requirements, the regulation prescribes collision warning systems such as Knorr-Bremse's Blind Spot Information System (BSIS) and Moving Off Information System (MOIS). And to improve general road safety and driver comfort, the pioneering Fusion Front ADAS uses a combination of front camera and radar to detect complex traffic situations and relevant objects. Knorr-Bremse's Electric Power Steering (EPS) system supports two of the most important developments in the commercial vehicle industry: electrification and automated driving. The company will also present its Advanced Hybrid Power Steering system (electrohydraulic AHPS). Perfect for implementing a wide variety of driver assistance functions, both systems support ADAS and HAD requirements and comply with all current standards such as ISO 26262.

In the field of Air Supply, Knorr-Bremse develops air-compression technologies that precisely match customer needs for various vehicle applications. The Rotary Vane Compressor features a new e-motor for electric commercial vehicles with low to medium air requirements. The Global Scalable Air Treatment (GSAT) technology platform overcomes the global challenges associated with electronic air treatment by combining all functions for all types of vehicles anywhere in the world in a single modular, scalable and integrated solution that complies with statutory and regulatory requirements worldwide. For manufacturers looking to create an even more cost-efficient, space-saving vehicle architecture, GSAT can also accommodate an electronic parking brake.

Knorr-Bremse's NexTT® is currently the market's lightest 22.5-inch disc brake for trailers. The intel-



KNORR-BREMSE'S BOOTH DESIGN is particularly sustainable. When the trade fair finishes, the individual information containers that make up the booth will become a roadshow for customers.

ligent electronic trailer braking system iTEBS® X is a new global platform that combines an electronic control unit, sensor technology and a pneumatic brake control system in a single, compact assembly, together with braking functions such as ABS and load-dependent braking. To accompany and enhance iTEBS X, Knorr-Bremse will be presenting a new, cloud-assisted configuration platform, Online Configuration Tool (OCT), as a futureproof diagnostics concept. The digital solution includes a Software Update Management System (SUMS) that complies with the new regulatory requirements of UNECE R156. And the new, UNECE R141-compliant iTPMS (tire pressure monitoring system) checks tire pressures and warns drivers of any anomalies.

ZERO emissions in road traffic is the ultimate goal for Knorr-Bremse's customers, and the company is systematically helping them to achieve it. Knorr-Bremse believes the future of the drivetrain will be characterized by diversity: Battery-electric vehicles, fuel-cell vehicles, hydrogen-burning vehicles – each technology has its own emission-reducing strengths. Because of Knorr-Bremse's in-depth understanding of the whole concept of a zero-emission vehicle and the fundamentally different vehicle architectures required, the company is producing the innovative solutions needed by individual customers. Knorr-Bremse has bundled this e-mobility expertise in the eCUBATOR innovation unit, while the global business units continue to work on improving the technologies required to cut down carbon, noise and particulate emissions, as well as oil consumption. Knorr-Bremse already plays a key role at the safety stage of the commercial vehicle approval process, and will expand this role to include emissions – specifically, brake-dust emissions – as EURO 7 is introduced.

Knorr-Bremse is already contributing to emissions reduction, for example with its SYNACT disc brake family. SYNACT achieves new levels of

performance, weight and efficiency, and can reduce a vehicle's carbon footprint using ACR, making SYNACT one of the most energy-efficient air disc brakes. The brake family's Noise, Vibration and Harshness (NVH) toolbox optimizes braking behavior to minimize noise emissions in city centers.

The EPS (Electric Power Steering) all-electric steering supports commercial vehicle electrification and uses a "power-on-demand" principle to reduce energy and fuel consumption, lowering both energy costs and carbon emissions. Knorr-Bremse is also a leader in the development of e-vehicle compressors optimized for low-noise, high-efficiency air supply systems.

As levels of automation increase, more and more functions are shifting from human to machine. As a result, trucks require system architectures with enough redundancy to support multiple safety-critical functions. This means that even if certain components develop faults, the vehicle can still safely perform the necessary functions. Here, Knorr-Bremse's focus is on braking, steering and power management systems, which can be turned into redundant systems by adopting a modular approach. Depending on the application, this can improve the availability of commercial vehicles operating at SAE levels 2 to 4 while simultaneously ensuring that they meet the highest safety standards. Knorr-Bremse's redundancy concepts do not depend on doubling up components, but on a smart, cost-efficient architecture that integrates primary and secondary pathways. Knorr-Bremse's approach also delivers scalable

solutions ranging from basic "limp-home" applications (vehicle continues to operate, but with reduced systems functionality) through to high-performance "mission-complete" applications (vehicle continues to operate with full systems functionality).

Knorr-Bremse offers OEMs and fleet operators new or digitally optimized products and services, as well as innovative business models. The company's cybersecure products meet stringent statutory cybersecurity compliance standards (UNECE R155). Knorr-Bremse TruckServices will demonstrate just how digitalization and connectivity can boost business development in the aftermarket segment. Knorr-Bremse's commercial vehicle aftermarket specialist has already redefined its ambitions for the future, and is planning to improve efficiency along the entire aftermarket value chain with its holistic ecosystem. Customers of Knorr-Bremse TruckServices attending Automechanika 2024 (in Frankfurt, September 10-14, 2024) will have an early opportunity to find out more. Among the new products that will increase workshop efficiency is Knorr-Bremse Diagnostics. Based on the user interface of brand-independent commercial vehicle diagnostics software Jaltest Diagnostics by Cojali, the software suite combines diagnostic tools for Knorr-Bremse truck and trailer systems in a single appliance. Fleets and workshops will be able to assemble customized packages of diagnostic tools to meet their own needs. As well as stationary in-workshop diagnostics, Knorr-Bremse is working with Cojali to rapidly expand its range of remote diagnostics and predictive maintenance products and services, while at the same time further optimizing them to include big data services.



MARTEX *automotive passion future*

A well-known brand in Europe

EXTENSIVE RANGE: Martex currently offers availability of around 100,000 items from more than 700 suppliers.

Polish parts wholesaler MARTEX is investing in consolidating its position in the international market - and this includes construction of a new central depot that will be around twice as big as the current one. Knorr-Bremse has had a close partnership with the company since 2015.



THE CURRENT WAREHOUSE IS IN DĄBROWA GÓRNICZA. By the third quarter of 2024 there will be a new building about twice the size of the current one.

“Having doubled sales in the last five years, MARTEX is now a well-known brand both in Poland and the rest of Europe,” reports Andrzej Parzoch, the company’s Vice-President and a member of the Board of Management. Founded in 1992, the company, based in Rybnik, Upper Silesia, now has a workforce of 800+ and can claim to be one of Poland’s leading truck parts wholesalers. But it is determined not to rest on its laurels and has plans for further expansion of its operations both at home and abroad.

» 2024 is a year of key investments aimed at consolidating our position in the spare parts market «

Andrzej Parzoch,

Vice President and a member of the MARTEX management board.



Its product range, which is aimed at service and transportation companies as well as domestic and international wholesalers, includes spare parts, consumables, oils and lubricants and accessories for trucks, buses and trailers. MARTEX also supports service companies with workshop equipment. "We have focused on ensuring that we cover the complete range," says Andrzej Parzoch. MARTEX, he says, closely monitors market developments in the commercial vehicle sector and constantly adapts its portfolio to changing customer needs. The fact that since 2015 the company has been the sole Polish shareholder in TEMOT International, has given an extra boost to its development. "This step has given us access to all major suppliers of commercial vehicle parts," he explains. The wholesaler boasts availability of around 100,000 items from more than 700 suppliers.

The human factor plays a decisive role in the development of the portfolio. "Managing such a large range calls for high-caliber specialists, and we have succeeded in building up such a team," explains Parzoch. "People are one of the most important factors in our development. We are so passionate about the future of the automotive industry that we don't waste a single day, and are constantly adding to our knowledge." MARTEX has been an authorized TruckServices Expert Network distributor for Knorr-Bremse brand parts since 2015. "We stock a wide range

EFFICIENT INTRALOGISTICS: MARTEX is relying on automation of parts supply. A guarantee of high levels of parts availability.

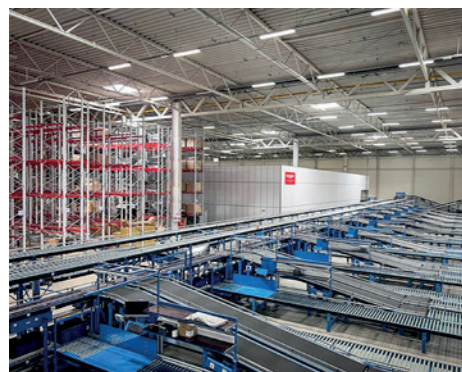

of products for commercial vehicles' air and braking systems," reports Andrzej Parzoch. "The close cooperation and commitment of Knorr-Bremse TruckServices, means our range is expanding year on year with new products and solutions." He is particularly proud of the quality of the product and sales training provided to MARTEX employees. But the relationship between the two companies goes further than mere business links. "Collaboration between Knorr-Bremse TruckServices and MARTEX has also resulted in personal relationships building up over the years," he explains. Regular contact, joint initiatives, training courses and events are evidence of mutual trust and an approach based on partnership.

This year, MARTEX intends to invest heavily in expanding its business. Above all this includes the construction of a new central warehouse, with an area of almost 45,000 square meters – twice the size of the existing one in Dąbrowa Górnicza, southern Poland. As from the third quarter of this year, this will supply the company's 42 branches throughout Poland. According to Andrzej Parzoch, storage, internal transport, sorting, picking and packing operation will be extensively automated at the new facility. The transportation sector has its own laws, one of which is that vehicle downtimes must be

minimized. One of MARTEX'S advantages is the fact that: "We guarantee high parts availability and efficient logistics at all times, with deliveries to our customers several times a day. This is the key to their ability to rapidly process maintenance and repair orders."

The work is bearing fruit: Three times since 2022, the consulting firm Deloitte Poland has designated MARTEX "Best Managed Company." In 2024, it was also one of the winners of the "Forbes Diamonds" survey. So the future continues to look good for MARTEX.

ON TRACK FOR GROWTH: MARTEX has a workforce of some 800 and has doubled its sales revenues in the last five years.



DEAR DISTRIBUTORS

THANK YOU

for putting your trust
in air dryer cartridges
from the global market
leader in original
equipment* – more
than 30 million times.



That's how often our air dryer cartridges have been used in servicing over the past 12 years alone. With good reason: only original means original, and only original parts can offer you consistent reliability, ease of installation, high longevity, long maintenance intervals and the associated reduced costs. Which is how we help you to KEEP IT RUNNING.

* Based on global market share in air treatment products for commercial vehicles



 **KNORR-BREMSE**

 **TRUCKSERVICES**